

USER MANUAL

Raymond Solid State 5.4kWh

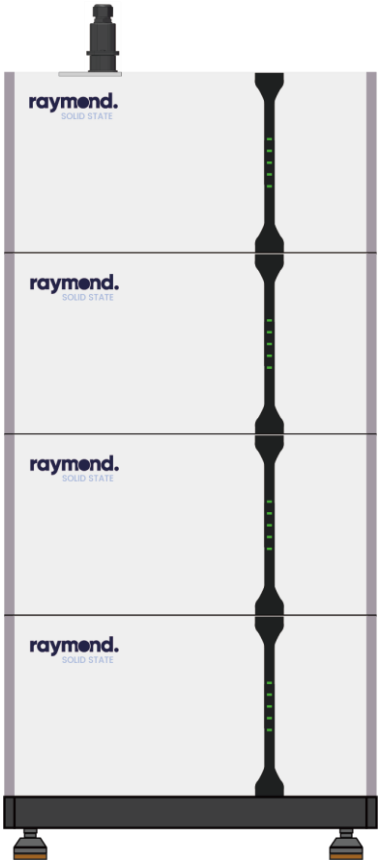

raymond.
SOLAR POWER. IT'S WATT YOU NEED.

Raymond Solar AB

About this manual

This manual is intended for the Raymond Solid State 5.4kWh Energy Storage battery. These batteries can only be installed in Series, pay more attention to the power cable and communication cable connection.

Statement

Compliant to Best Practice Guide for Battery Storage Equipment—Electrical Safety. Requirements- version 1- Pre-assembled integrated battery energy storage system equipment – Method 1 mandatory requirements and Optional requirements – a), c), e), f), g), h), i), j), k), l), m), n), o), p), q).

Declaration

Raymond declares that the Raymond Solid State 5.4kWh is in compliance with the essential requirements and other relevant of RE Directive 2014/53/EU.

INDEX

- 1. Safety Introduction 3
 - 1.1 Important Safety Instructions..... 3
 - 1.2 Warnings in this Document 3
 - 1.3 Battery Handling Guide 4
 - 1.4 Response to Emergency Situations 4
 - 1.4.1 Leaking Batteries..... 4
 - 1.4.2 Fire 4
 - 1.4.3 Wet battery 5
 - 1.4.4 Damaged Battery 5
 - 1.5 Installers 5
 - 1.6 Scrap Battery 6
 - 1.7 Contact Information 6
- 2. Guidance for Disconnection of Batteries During Shipment 6
 - 3.1 Technical Specifications..... 7
 - 3.2 Indicators and Ports 8
 - 3.2.1 Indicators 8
 - 3.2.2 Power and Communication Ports 8
 - 3.3 Solution of Raymond 10
 - 3.4 Feature 11
- 4. Installation Prerequisites 11
 - 4.1 Installation Process 11
 - 4.3 Tools..... 12
 - 4.4 Safety Instruments..... 13
 - 4.5 Storage 13
- 5. Battery Installation..... 14
 - 5.1 Package Items 14
 - Battery carton: 14
 - Base carton:..... 15
 - 5.2 Checks Before Installation 15
 - 5.3 Battery Installation 16
 - 5.3 Connection Between Batteries 17
- 6. Configuration 18
 - 6.1 Download the app..... 18
 - 6.2 Configure Battery WIFI 19
- 7 Commissioning 21
 - 7.1 Installation & Commissioning step by step..... 21
 - 7.2 Shutting Down Battery 21
- 8. Firmware Update 21

1. Safety Introduction

1.1 Important Safety Instructions







This manual contains important instructions for:

Raymond Solid State 5.4kWh Energy Storage product and this manual must be followed when installing and using this product.

This product is designed and tested in accordance with international safety requirements CE, but as with all electrical and electronic equipment, certain precautions must be observed when installing and operating the product. To reduce the risk of personal injury. Ensure the installation safety and operation of the product, you must read carefully and follow all instructions, cautions, and warnings in this manual.

1.2 Warnings in this Document

A warning describes a hazard to equipment or personnel. It calls attention to a procedure or practice which if not correctly performed, can result in damage to or destruction of part or all of the Raymond equipment and/or other equipment connected to the Raymond equipment or personal injury.

Symbol	Description
	Caution, risk of electric shock
	Heavy enough may cause severe injury
	Keep the battery away from open flame or ignition sources
	Keep the battery away from children
	Dispose of waste batteries according to local laws and regulations
	Recycling
	Read this manual before installation and operation

For safety reasons, installers are responsible for familiarizing themselves with the contents of this manual and all warnings before performing installation.

1.3 Battery Handling Guide

- To protect the battery and its components from damage when transporting, handle them with care.
- Do not subject it to any strong force.
- Do not insert foreign objects into any part of the battery pack.
- Do not use cleaning solvents to clean the battery.
- The battery cannot be connected directly to the SELV circuit.
- Use the battery pack only as directed.
- If the battery is defective, appears cracked, is broken, gets other damage, or fails to operate. Contact the Raymond hotline +46(0)10-188 20 30 immediately.
- Do not attempt to open, disassemble, repair, tamper, or modify the battery.
The battery is not suitable for users to use by themselves.

1.4 Response to Emergency Situations

The Raymond battery is designed with multiple safety strategies to prevent hazards resulting from failures. However, Raymond cannot guarantee their absolute safety in uncertain situations.

1.4.1 Leaking Batteries

If the battery pack leaks electrolyte, avoid contact with the leaking liquid or gas. Electrolyte is corrosive and contact may cause skin irritation and chemical burns. If one is exposed to the leaked substance, do these actions:

- **Inhalation:** Evacuate the contaminated area, and seek medical attention immediately.
- **Eyes contact:** Rinse eyes with flowing water for 15 minutes, and seek medical attention immediately.
- **Skin contact:** Wash the affected area thoroughly with soap and water, and seek medical attention immediately.
- **Ingestion:** Induce vomiting as soon as possible, and seek medical attention immediately.

1.4.2 Fire

In case of a fire, make sure that an ABC or carbon dioxide extinguisher is nearby and does not use water to extinguish the fire.



WARNING

The battery pack may catch fire when heated above 150°

If a fire breaks out where the battery is installed, do these actions:

1. Extinguish the fire before the battery catches fire.
2. If the battery has caught fire, do not try to extinguish the fire. Evacuate people immediately.

WARNING

If the battery catches fire, it will produce poisonous gases. Do not approach.

1.4.3 Wet battery

If the battery is wet or submerged in water, do not try to access it. Contact **Raymond Customer Service** or your distributor for technical assistance.

1.4.4 Damaged Battery

If the battery is damaged, please contact Raymond **customer service** or your distributor for help as soon as possible, because damaged batteries are dangerous and must be handled with extreme caution. Damaged batteries are not suitable for use and may cause a danger to people or property. If the battery seems to be damaged, return it to Raymond or your distributor.

CAUTION

Damaged batteries might export electrolyte or flammable gas, so contact Raymond for advice and information immediately. Raymond will deal with it.

1.5 Installers

Raymond Energy Storage battery is suggested to be installed by skilled workers or electricians. A skilled worker is defined as a person who has been trained and qualified electrician or has all of the following skills and experience:

- Knowledge of the functional principles and operation of on-grid Energy Storage systems.
- Knowledge of the dangers and risks associated with installing and using electrical devices and acceptable mitigation methods.
- Knowledge of the installation of electrical devices
- Knowledge of and adherence to this manual, all safety precautions and best practices.

1.6 Scrap Battery

For scrap battery(-ies), please treat with local laws or regulations to recycle or scrap.

1.7 Contact Information

Use the contacts for technical assistance. The phone number is available only during business hours on weekdays.

Tel	+46(0)10-188 20 30
Email	info@raymondsolar.com
Address	Designvägen 2 435 33 Mölnlycke

2. Guidance for Disconnection of Batteries During Shipment

- Raymond Solid State 5.4kWh is not suitable for air transport.
- Cartons that have been crushed, punctured, or torn in such a way that contents are revealed shall be set aside in an isolated area and inspected by a skilled person. If the package is deemed not to be shippable, the contents shall be promptly collected and segregated, and either the consignor or the consignee contacted.
- The DC circuit of Raymond Solid State 5.4kWh battery has been disconnected before outgoing.
- We have conducted comprehensive tests to ensure the equipment distributed around the world is safe for shipping. These products shall be handled with care and immediately inspected if visibly damaged. If the carton is visibly damaged, please contact with **Raymond customer service** to confirm whether the battery can be used safely or not.

3.Product Introduction

3.1 Technical Specifications

Product Type	Raymond Solid State 5.4kWh	Raymond 10.8kWh	Raymond 16.2kWh	Raymond 21.6kWh	Raymond 27kWh	Raymond 32.4kWh
Total Energy*	5.4kWh	10.8kWh	16.2kWh	21.6kWh	27kWh	32.4kWh
Battery Capacity	53Ah					
Max Recommended DOD	93%					
Peak Discharge Power	6.0kW for 3S	12.3kW for 3S	18.4kW for 3S	24.6kW for 3S	30.8kW for 3S	36.9kW for 3S
Nominal Dis/Charge Current	50A					
Voltage	96-112Vd.c Vd.c	192-224 Vd.c	288-336 Vd.c	384-448 Vd.c	480-560 Vd.c	576-672 Vd.c
Nominal Voltage	102.4Vd.c	204.8Vd.c	307.2Vd.c	409.6Vd.c	512.5Vd.c	614.4Vd.c
Max Dis/Charge Current	50A					
Max Charge Voltage	115.2Vd.c	230.4Vd.c	345.6Vd.c	460.8Vd.c	576Vd.c	691.2Vd.c
Weight(N.W.)	53kg/54kg	106kg/108kg	159kg/162kg	212kg/216kg	265kg/270kg	318kg/324kg
Dimension(L*W*H)	660*300*320mm	660*300*700mm	660*300*1000mm	660*300*1300mm	660*300*1600mm	660*300*1900mm
Operating Condition	Indoor & Outdoor (with shelter)					
Operating Temperature(ce ll)	Charge	From 0-55°C				
	Discharge	From -20-55°C				
Bluetooth Frequency Range	2400-2483MHz					
Bluetooth Max.transmission power	7.5dBm					
WIFI Frequency Range	2400-2483MHz					
WIFI Max.transmission power	17.8dBm					
Humidity	<60%(No condensed water)					
Over Voltage Category	II					
Cooling Type	Natural cooling					
Installation	Ground Installation					
IP Rating	IP65					
Protective Class	I					
Max Connection Number	6S					
Communication	CAN/ RS485					
Protection Mode	Hardware&software protection					
Battery Protection	Over-current/Over-voltage/Short circuit/ Under-voltage/Over temperature					
Safety	Cell UL TUV					
	CE/TUV					
Hazardous Material Classification	9					
Transportation	UN 38.3					
Product Warranty	10 years warranty					

Testing conditions are based on a temperature 25°C at the beginning of life.

*Total Energy/Usable Energy measured under specific conditions from Raymond 0.2C CC-CV.

3.2 Indicators and Ports

3.2.1 Indicators

There are LED indicators on the front of the battery to show its operating status.

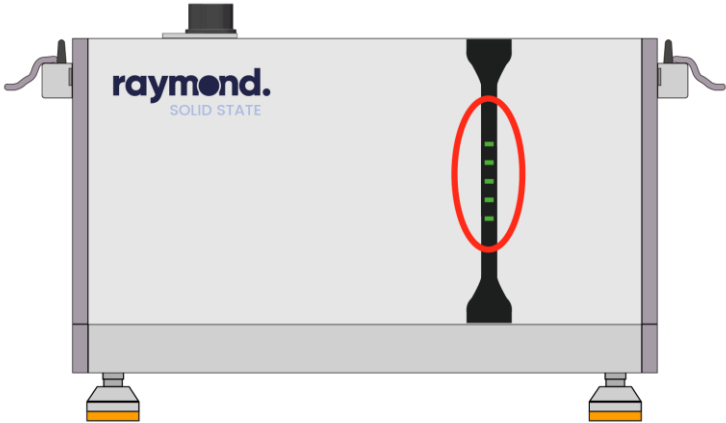

Item	Designation	Definition
1	SOC	Showing the SOC of battery

3.2.2 Power and Communication Ports

This is plug and play structure between the batteries, no additional wire is required:

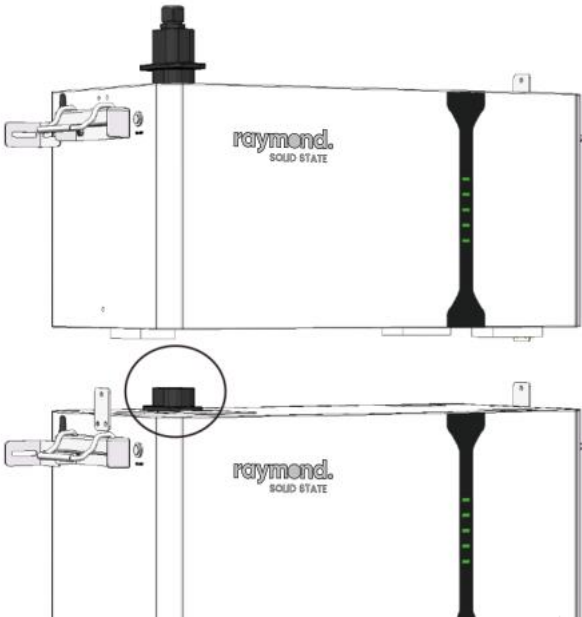

The master battery to inverter:

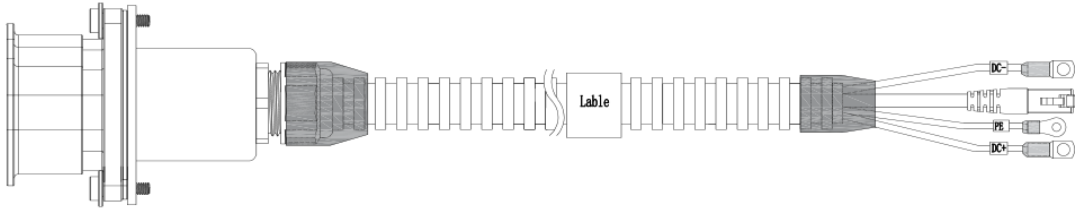

CAUTION	
	By CAN communicating with inverter. connect INV_CANH and INV_CANL to the inverter.
	By RS485 communicating with inverter. connect INV_RS485_A and INV_RS485_B to the inverter.
	The communication cable of BAT_CANH and BAT_CANL are used for after sales team to configure program by CAN box (monitor).

Battery PIN definition

Battery RJ45 CAN/RS 485		
PIN	Color	Signal Name
1	Orange&white	BAT_CANH
2	Orange	BAT_CANL
3	Green&white	NA
4	Blue	INV_CANH
5	Blue&white	INV_CANL
6	Green	NA
7	Brown&white	INV_RS485_A
8	Brown	INV_RS485_B

3.3 Solution of Raymond

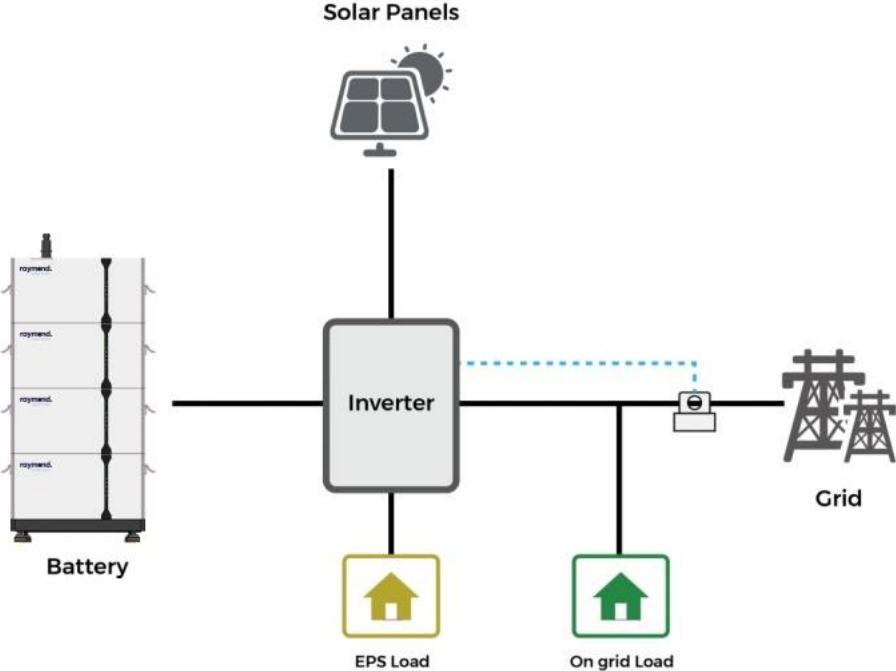

3.4 Feature

The Raymond Energy Storage battery has the following features:

- **Energy storage unit:** This battery is suitable for photovoltaic system compatibility.
- **Battery management system (BMS):** The built-in battery BMS monitors its operation and prevents the battery from operating outside design limitations.
- **Monitor:** The built-in battery BMS has WIFI module, and the battery operating information can be seen on mobile phones and computers.
- **Easy firmware update:** The BMS firmware can be updated to the latest version.
- **Expansibility:** The battery capacity can be increased by adding another battery.

4. Installation Prerequisites

4.1 Installation Process

The battery should be installed according to the following flow chart. The detailed installation process is described in Chapter 5 **Install process**.

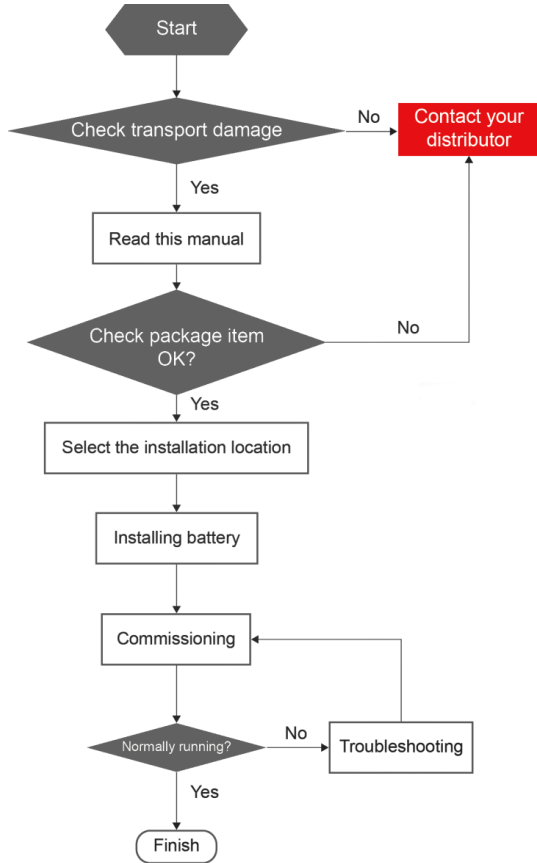

4.2 Installation Position









Make sure that the installation position meets the following conditions:

- The building is designed to withstand earthquakes.
- Far away from the sea to avoid salt water and humidity, should be installed at least 500 meters away from seawater.
- The floor is flat and level.
- No flammable or explosive materials nearby.
- Optimal ambient temperature is between 15°C and 30°C.
- Temperature and humidity stay at a constant level.
- Minimal dust and dirt in the area.
- No corrosive gases present, including ammonia and acid vapor.
- The battery is rated at IP65, therefore the battery is suitable for indoor and outdoor with shelter usage.

If the ambient temperature is out of the operating range, the battery will protect itself by shutting down. The battery’s optimal operating temperature is 15°C to 30°C. Frequent exposure to severe operating conditions will exacerbate the performance and lifetime of the battery.

4.3 Tools

To install the battery pack, the following tools are required:

			
Phillips screwdriver	Torque wrench	Cable crimper	Wire clamp
			
Voltmeter	Tape measure	Drill	Flat-head screwdriver

In order to protect the operator and installer’s safety, please select and use suitable tools and measuring instruments that are certified for precision and accuracy.

4.4 Safety Instruments

When dealing with the battery, the following safety gear should be equipped.

Installers

must meet the relevant requirements of IEC 62040 and IEC 62619 or the domestic legislation and other relevant international standards.



4.5 Storage

If the battery is not to be installed immediately, and needs to be stored for a long time, please choose an appropriate location to store it. Instructions for storage are:

- Do not stack more than four battery boxes.
- The recommended storage temperature of the battery is in the range of -20°C to 30°C .
- Do not expose to water
- The battery box should be upright as shown in the following figure and shouldn't be stacked upside down when storing the battery box.

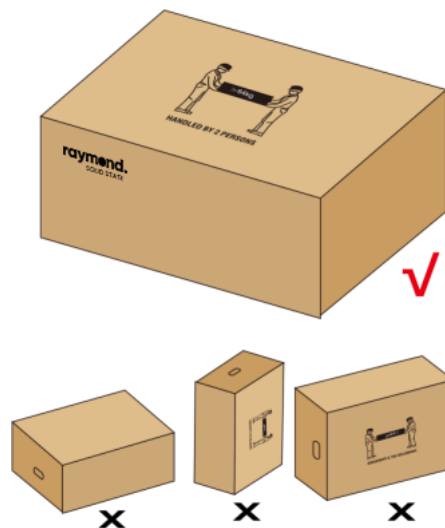

- If the battery needs to be stored over 3 months, the battery will discharge at a minimum rate and capacity will degrade depending on storage time.
- If the battery will be stored over 6 months, it is suggested to connect the battery with the inverter and commission the system.





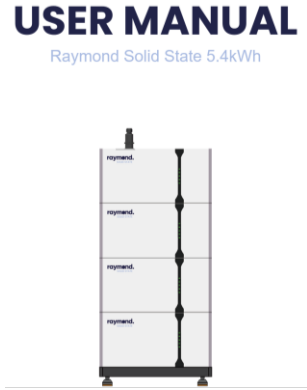

5. Battery Installation

5.1 Package Items

Battery carton:

	<h2 style="text-align: center;">USER MANUAL</h2> <p style="text-align: center;">Raymond Solid State 5.4kWh</p> 	<p style="text-align: right;">raymond.</p> <p>Raymond Solar AB Designlgården 2, 435 03 Mölndals Sweden</p> <p style="text-align: right;">Limited Warranty</p> <p style="text-align: right;"><small>Effective Date: 1st March, 2024 Doc No.: RD-055-2024-V10</small></p> <p>1. Warrantor Warrantor is Raymond Solar AB (the Company or Raymond) with its registered address of Designlgården 2, 435 03 Mölndals, Sweden.</p> <p>2. What Products are covered This following warranty applies to the Product listed in Appendix 1 which were <ul style="list-style-type: none"> manufactured by the Company; sold by the Company directly or through the authorized resellers as new products, and were installed and commissioned by a certified installer. </p> <p>3. Warranty The Company provides 10 (ten) years of warranty for the capacity retention. The Company warrants at least 75% of nominal battery capacity up to 10 years (capacity measurement condition: ambient temperature range 25 ± 2 °C, 0.20C charge, 0.20C discharge, 1 full cycle charge and discharge per day) in the first 5 years. If there's product quality problem, including BMS, accessories, even batteries, you can replace related products for free. In the second 5 years, if there's BMS problem, you can replace BMS for free.</p> <p>The warranty period commences from the earlier of the date of initial installation or the 180th day after the date which the Product was manufactured.</p> <p>During the first five (5) years of the warranty period, there shall be no defects in workmanship or materials in accordance with the Usage and Transportation Requirements in Appendix 2, and under the normal application, installation, use, and service conditions specified in the user manual provided by our company.</p> <p>4. Preconditions for Warranty This warranty is subject to the following conditions: <ul style="list-style-type: none"> The Product has been installed and correctly commissioned by a certified installer. Proof may be required of correct commissioning of the Product (such as certificate of compliance). Claims for failures due to incorrect installation or commissioning are not covered under this Warranty. The original serial number and rating label of the product are intact and readable. This Warranty does not extend to any Product that has been completely or partially disassembled or modified unless such disassembly is carried out by the Company. Any warranty claim under this Warranty must meet the requirements set out below in the "Claim Procedure" section. The Product shall be correctly operated and used according to User Manual and conditions set out in this Warranty. The operating temperature for the Product must not exceed 20°C–55°C range and the Product shall not be exposed to and stored in a temperature higher than 50°C, and shall not be exposed in an installed area to direct sunlight. The Product installation location must be ventilated in accordance with the requirements of User Manual. </p> <p style="text-align: right;"><small>Raymond Product Limited Warranty</small></p>																																																																																						
Battery*1	User Manual*1	Warranty*1																																																																																						
<table border="1" style="width: 100%;"> <tr> <td style="width: 60%;">RAYMOND</td> <td style="width: 20%;">Overpass Quality Control Report</td> <td style="width: 10%;">No.</td> <td style="width: 5%;">Revision</td> <td style="width: 5%;">Re-Revision No.</td> </tr> <tr> <td></td> <td></td> <td>JL 02-03</td> <td>3</td> <td>0</td> </tr> </table> <p style="text-align: center;">Quality Report</p> <p>Production No. _____ Product Type: SOLID STATE</p> <table border="1" style="width: 100%;"> <thead> <tr> <th>Item</th> <th>Inspection Item</th> <th>Standard</th> <th colspan="2">Result</th> </tr> </thead> <tbody> <tr> <td rowspan="2">Visual</td> <td>Appearance, Nameplate Label</td> <td>No damage, dirt, scratch, deformation etc. Marking shall not be printed upside down or right side</td> <td><input type="checkbox"/> OK</td> <td><input type="checkbox"/> N/G</td> </tr> <tr> <td rowspan="3">Charge & Discharge test</td> <td>Charge with 0.1C to a maximum of 90% when charging current has less than 0.025A</td> <td><input type="checkbox"/> OK</td> <td><input type="checkbox"/> N/G</td> </tr> <tr> <td>Max. Charge</td> <td><input type="checkbox"/> OK</td> <td><input type="checkbox"/> N/G</td> </tr> <tr> <td>Discharge with 0.1C to 0.01V method to end</td> <td><input type="checkbox"/> OK</td> <td><input type="checkbox"/> N/G</td> </tr> <tr> <td rowspan="2">Test</td> <td>TEST RESULT</td> <td>Criteria Discharge capacity > 4900</td> <td><input type="checkbox"/> OK</td> <td><input type="checkbox"/> N/G</td> </tr> <tr> <td>Self-discharge voltage difference</td> <td>Less than 4% after discharge, the Max. voltage difference among 10 modules or parallel should be less than 50mV</td> <td><input type="checkbox"/> OK</td> <td><input type="checkbox"/> N/G</td> </tr> <tr> <td rowspan="3">Resistance</td> <td>Internal resistance</td> <td>Maximum average per module < 10mΩ (between positive and negative copper) < 40mΩ</td> <td><input type="checkbox"/> OK</td> <td><input type="checkbox"/> N/G</td> </tr> <tr> <td>Product voltage</td> <td>The product voltage should be 750VDC which measured by voltmeter correctly.</td> <td><input type="checkbox"/> OK</td> <td><input type="checkbox"/> N/G</td> </tr> <tr> <td>WFI test</td> <td>WFI value correspond with Battery BMS and modules confirmed in manual.</td> <td><input type="checkbox"/> OK</td> <td><input type="checkbox"/> N/G</td> </tr> <tr> <td rowspan="2">Weight</td> <td>Insulation performance</td> <td>AC 1000V surge, product insulation resistance less than 100Ω</td> <td><input type="checkbox"/> OK</td> <td><input type="checkbox"/> N/G</td> </tr> <tr> <td>Weight</td> <td>Product weight should be 15.2kg</td> <td><input type="checkbox"/> OK</td> <td><input type="checkbox"/> N/G</td> </tr> <tr> <td>Accessory</td> <td>Accessory</td> <td>Product test report, user manual, screws and other accessories packed with battery.</td> <td><input type="checkbox"/> OK</td> <td><input type="checkbox"/> N/G</td> </tr> <tr> <td>Result</td> <td colspan="2"></td> <td><input type="checkbox"/> OK</td> <td><input type="checkbox"/> N/G</td> </tr> <tr> <td>Inspector</td> <td>Zhangli</td> <td>Checked by:</td> <td colspan="2">Jiangli</td> </tr> <tr> <td>Note</td> <td colspan="4"></td> </tr> <tr> <td>Locker:</td> <td>Jiangli</td> <td>Date:</td> <td colspan="2">May 28, 2024</td> </tr> </tbody> </table>	RAYMOND	Overpass Quality Control Report	No.	Revision	Re-Revision No.			JL 02-03	3	0	Item	Inspection Item	Standard	Result		Visual	Appearance, Nameplate Label	No damage, dirt, scratch, deformation etc. Marking shall not be printed upside down or right side	<input type="checkbox"/> OK	<input type="checkbox"/> N/G	Charge & Discharge test	Charge with 0.1C to a maximum of 90% when charging current has less than 0.025A	<input type="checkbox"/> OK	<input type="checkbox"/> N/G	Max. Charge	<input type="checkbox"/> OK	<input type="checkbox"/> N/G	Discharge with 0.1C to 0.01V method to end	<input type="checkbox"/> OK	<input type="checkbox"/> N/G	Test	TEST RESULT	Criteria Discharge capacity > 4900	<input type="checkbox"/> OK	<input type="checkbox"/> N/G	Self-discharge voltage difference	Less than 4% after discharge, the Max. voltage difference among 10 modules or parallel should be less than 50mV	<input type="checkbox"/> OK	<input type="checkbox"/> N/G	Resistance	Internal resistance	Maximum average per module < 10mΩ (between positive and negative copper) < 40mΩ	<input type="checkbox"/> OK	<input type="checkbox"/> N/G	Product voltage	The product voltage should be 750VDC which measured by voltmeter correctly.	<input type="checkbox"/> OK	<input type="checkbox"/> N/G	WFI test	WFI value correspond with Battery BMS and modules confirmed in manual.	<input type="checkbox"/> OK	<input type="checkbox"/> N/G	Weight	Insulation performance	AC 1000V surge, product insulation resistance less than 100Ω	<input type="checkbox"/> OK	<input type="checkbox"/> N/G	Weight	Product weight should be 15.2kg	<input type="checkbox"/> OK	<input type="checkbox"/> N/G	Accessory	Accessory	Product test report, user manual, screws and other accessories packed with battery.	<input type="checkbox"/> OK	<input type="checkbox"/> N/G	Result			<input type="checkbox"/> OK	<input type="checkbox"/> N/G	Inspector	Zhangli	Checked by:	Jiangli		Note					Locker:	Jiangli	Date:	May 28, 2024			
RAYMOND	Overpass Quality Control Report	No.	Revision	Re-Revision No.																																																																																				
		JL 02-03	3	0																																																																																				
Item	Inspection Item	Standard	Result																																																																																					
Visual	Appearance, Nameplate Label	No damage, dirt, scratch, deformation etc. Marking shall not be printed upside down or right side	<input type="checkbox"/> OK	<input type="checkbox"/> N/G																																																																																				
	Charge & Discharge test	Charge with 0.1C to a maximum of 90% when charging current has less than 0.025A	<input type="checkbox"/> OK	<input type="checkbox"/> N/G																																																																																				
Max. Charge		<input type="checkbox"/> OK	<input type="checkbox"/> N/G																																																																																					
Discharge with 0.1C to 0.01V method to end		<input type="checkbox"/> OK	<input type="checkbox"/> N/G																																																																																					
Test	TEST RESULT	Criteria Discharge capacity > 4900	<input type="checkbox"/> OK	<input type="checkbox"/> N/G																																																																																				
	Self-discharge voltage difference	Less than 4% after discharge, the Max. voltage difference among 10 modules or parallel should be less than 50mV	<input type="checkbox"/> OK	<input type="checkbox"/> N/G																																																																																				
Resistance	Internal resistance	Maximum average per module < 10mΩ (between positive and negative copper) < 40mΩ	<input type="checkbox"/> OK	<input type="checkbox"/> N/G																																																																																				
	Product voltage	The product voltage should be 750VDC which measured by voltmeter correctly.	<input type="checkbox"/> OK	<input type="checkbox"/> N/G																																																																																				
	WFI test	WFI value correspond with Battery BMS and modules confirmed in manual.	<input type="checkbox"/> OK	<input type="checkbox"/> N/G																																																																																				
Weight	Insulation performance	AC 1000V surge, product insulation resistance less than 100Ω	<input type="checkbox"/> OK	<input type="checkbox"/> N/G																																																																																				
	Weight	Product weight should be 15.2kg	<input type="checkbox"/> OK	<input type="checkbox"/> N/G																																																																																				
Accessory	Accessory	Product test report, user manual, screws and other accessories packed with battery.	<input type="checkbox"/> OK	<input type="checkbox"/> N/G																																																																																				
Result			<input type="checkbox"/> OK	<input type="checkbox"/> N/G																																																																																				
Inspector	Zhangli	Checked by:	Jiangli																																																																																					
Note																																																																																								
Locker:	Jiangli	Date:	May 28, 2024																																																																																					
Quality Report																																																																																								

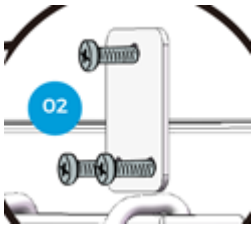
Base carton:

				
				
Base*1				
				
Base Foot*4	Integrated cables*1	Tail plug*1	Screw & panels*some	Wall fixed panel & screws *2

5.2 Checks Before Installation

There are a few things to check before installing the battery to ensure that it has no defects.

Check the battery voltage according to the following instruction:

- Press and hold the panel button for 4s and release after indicators turning on.
- Measure the voltage at the terminal interface with a voltmeter. If the voltage is lower

than 96V, do not use the battery and contact customer service.

5.3 Battery Installation

Place the Battery in the right place. (the details about the installation position are described in Chapter 4.2).

Once it was installed outdoor, a shelter is needed, warning that **NO rainy and direct sunshine on batteries.**

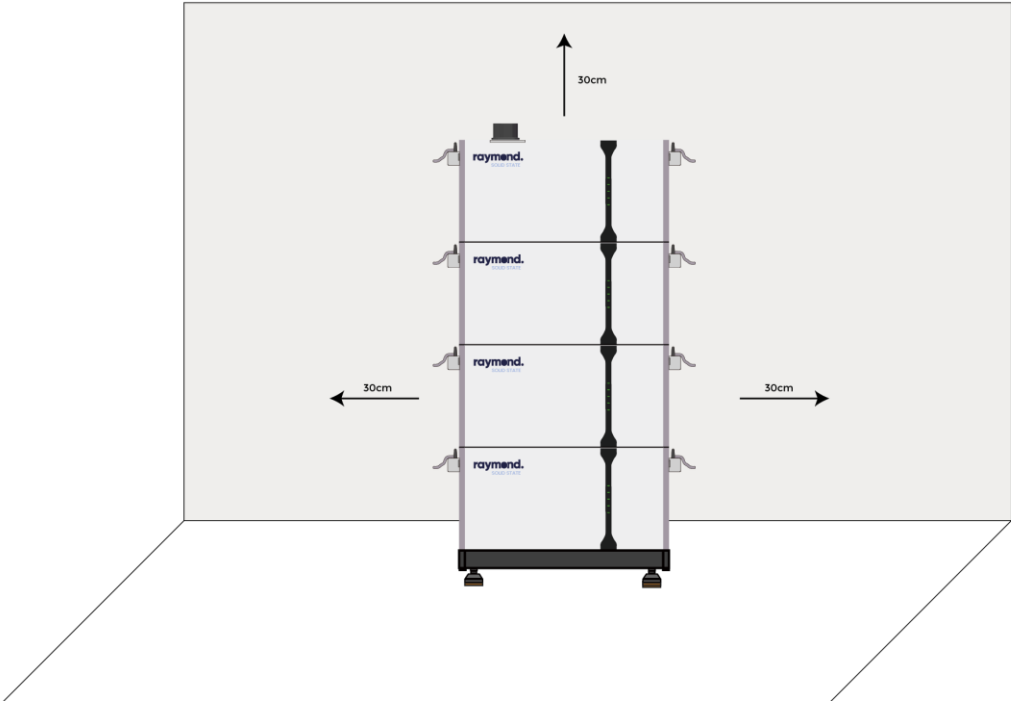

5.3 Connection Between Batteries

- 1. Install the tail plug: A tail plug should be installed to the bottom of the last battery in one cluster, so that it forms a full circuit

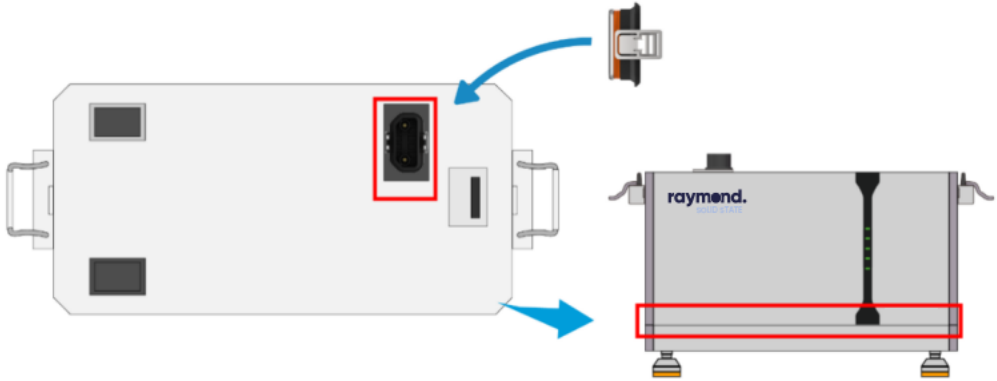

- 2. Turn on the Breaker: Breaker is on the top of the battery covered by a panel, open the panel. Turn on the Breaker and install the panel again.

Breaker on the top battery of the whole system should be turn off after the voltage check, until all cables connected and the whole system ready for start-up.

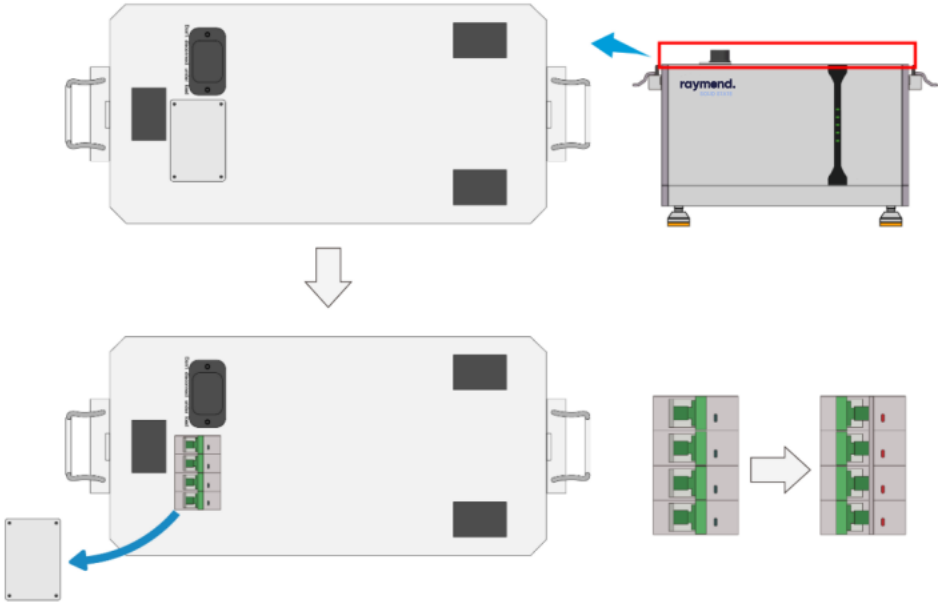

- 3. This product is easily mounted, just plug the upper battery into the lower one as below. Then fix the device to the wall with M6 expansion screws tightly.

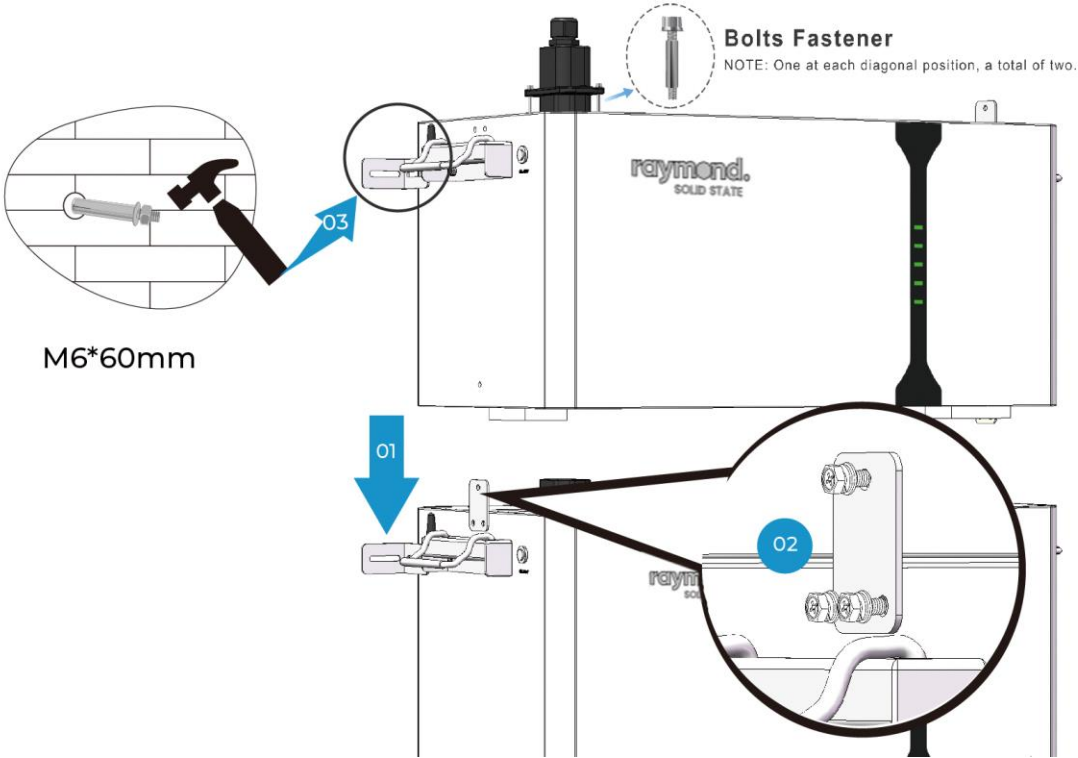

6.Configuration

6.1 Download the app: Search for the Raymond Solid State Installer app in the Google Play Store or Apple App store and download.

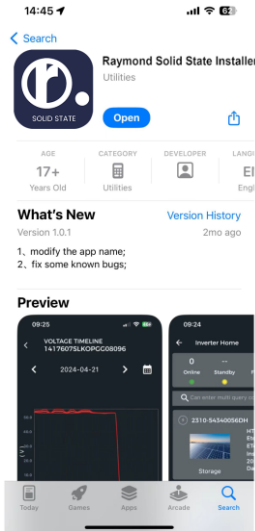
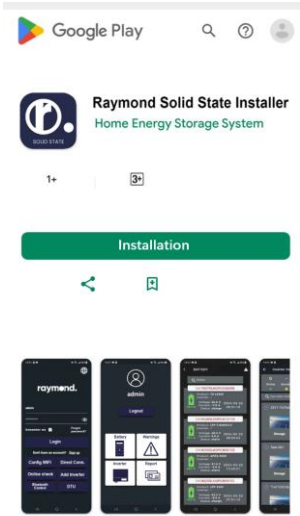

6.2 Configure Battery WIFI

The battery has a built-in WIFI module for use with the App.



- 1. Press the power button and turn on the battery.
- 2. Turn on Bluetooth and turn on the WIFI button.

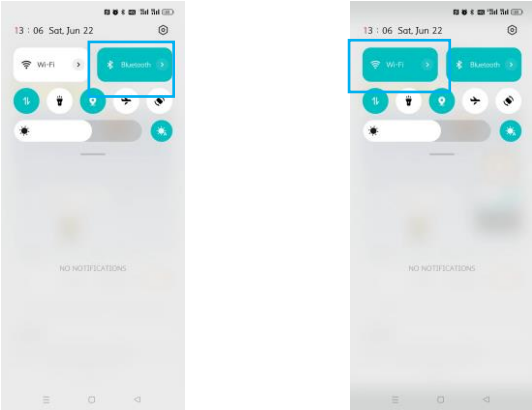

- 3. **User Registration:** Open the app, select "Sign up", automatically redirect to barcode scanning page. Scan the battery barcode or Enter Device SN; input inverter details, and fill out user information on the following pages.

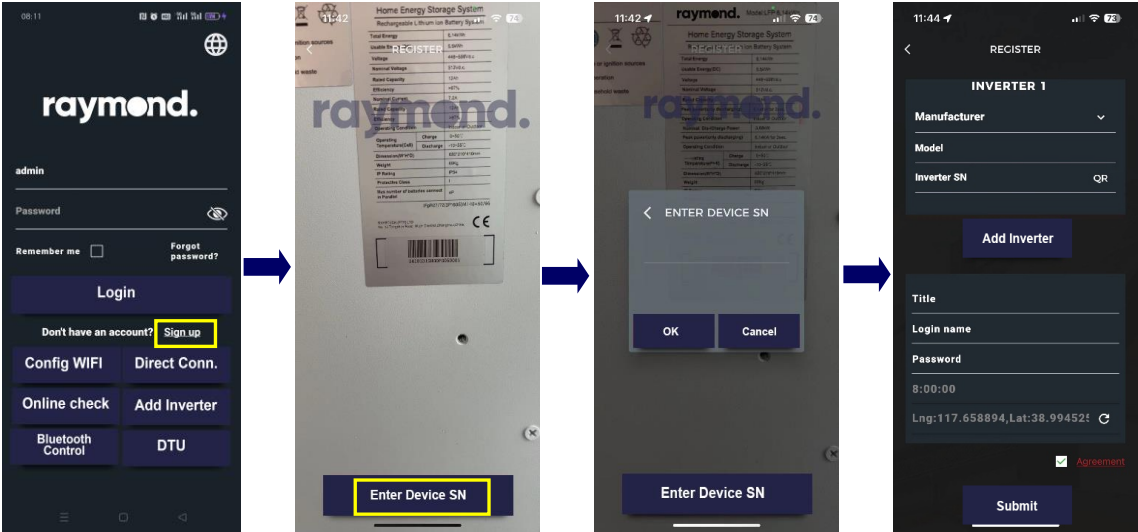

4. Scan or manually enter Device SN to add a new battery by clicking the  button on the Battery page.

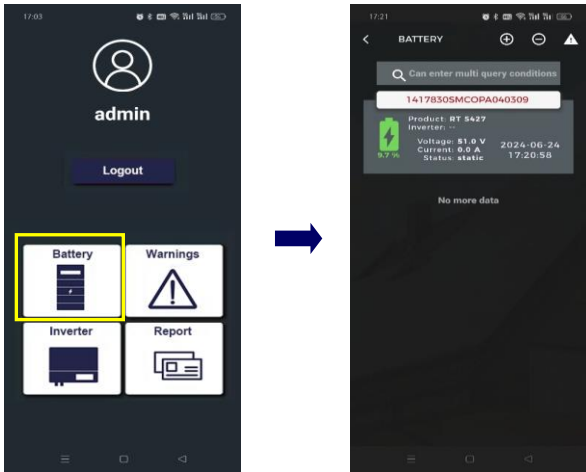

5. Configure the network before Login

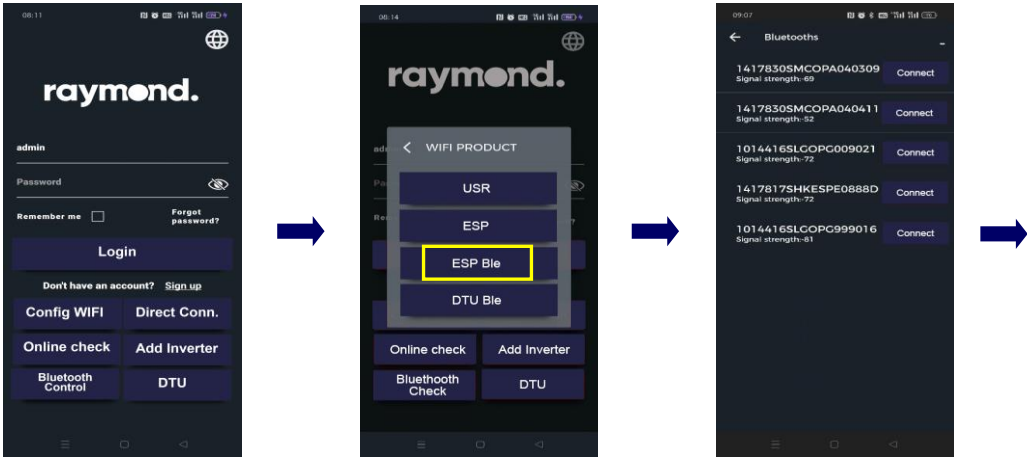

Click 'Config WiFi'

Click 'ESP Ble'

Displayed batteries

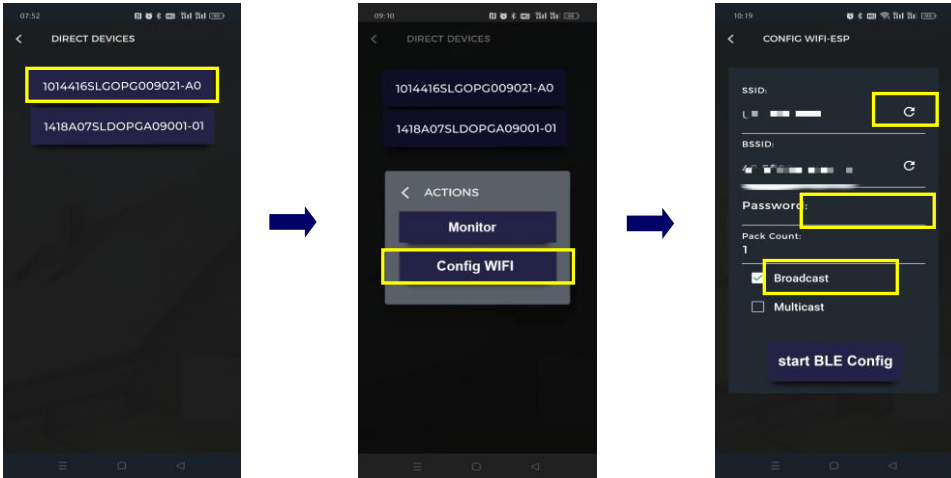

Select the battery

Click 'Config WiFi'

Network Configuration

7 Commissioning

7.1 Installation & Commissioning step by step

1. Test the voltage of each pack: insert the tail plug to the bottom of each pack, turn on the Breaker on the top. Then you can get a full circuit and a correct voltage. Each Voltage should be over 96V. otherwise contact with customer service.
2. Ensure that Maximum voltage difference between battery packs in one system should be less than 2V. Otherwise, contact with customer service.
3. Check the battery, Press and hold the panel button for 4s and release after indicators turning on, then turn off the battery. Turn off the breaker.
4. Battery base in the last layer of the whole system.
5. The 1st battery which already inserting the tail plug, turn on the Breaker, re-cover the panel. Put on the top of the Battery base.
6. The 2nd battery with the Breaker "on" put on the top directly. Then copy the process the 3rd one, 4th, 5th,6th.
7. The last Battery which is on the top of the whole system. Turn "off" the Breaker to avoid electric shocks. Stacking on the top.
8. Connect the power cable and communication cable between batteries and the inverter.
9. Check all connection on cables, turn "on" the Breaker of the top battery, re-cover the panel on it.
10. Turn on the inverter, the inverter could awake the batteries, indicator lights on batteries will light up. Or Turn on the top battery, press and hold the panel button for 4S, after all the indicator lights light up.
11. Setting on the inverter: battery type, charging & discharging and etc.
12. Configuration WIFI on the APP. Raymond Solid State 5.4kWh
13. Fixed the battery with the base, Fixed batteries with each other, Fixed the cluster to the wall.

7.2 Shutting Down Battery

Shut down the battery only when the battery is no charging or discharging which can be seen in your phone with APP.

1. Press and hold the Panel Button for 5s, release after the whole lights are off.

8. Firmware Update

If you need to upgrade the BMS software version, please contact the after-sales staff info@raymondsolar.com.

RED Declaration of Conformity (DoC)

Unique identification of this DoC:

We,

Raymond Solar AB
Designvägen 2, 435 33 Mölnlycke, Sweden

.....

Declare under our sole responsibility that the product:

Product name: RECHARGEABLE LITHIUM ION BATTERY
Trade name: Raymond
Type or model: Raymond Solid State 5.4kWh

Relevant supplementary information:
(e.g. lot, batch or serial number, sources and numbers of items)

To which this declaration relates is in conformity with the essential requirements and other relevant requirements of the RED Directive (2014/53/EU).

The product is in conformity with the following standards and/or other normative documents:

HEALTH & SAFETY (Art. 3(1)(a)): EN 62311:2008, EN IEC 62311:2020, EN 50663:2017

EMC (Art. 3(1)(b)): EN IEC 61000-6-1:2019, EN IEC 61000-6-3:2021, EN 301 489-1 V2.2.3:2019, EN 301 489-17 V3.2.4:2020SPECTRUM (Art. 3(2)): EN 300 328 V2.2.2:2019

OTHER (incl. Art. 3(3) and voluntary specs): N/A

Accessories: N/A

Software: N/A

Technical file held by: Raymond Solar AB
Place and date of issue (of this DoC):

Signed by or for the manufacturer:
(Signature of authorised person)

Name (in print):
Title: